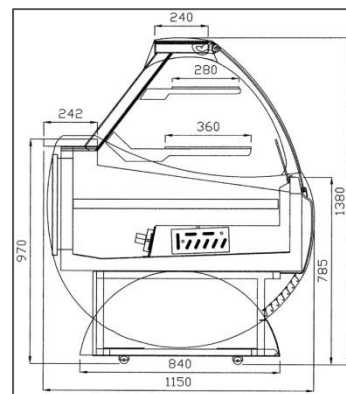

## Vitrinas para Pastelería - Deli "ASPEN PASTRY" Mod. DELI-12

Modelo "ASPEN"	Voltaje	Sistema Enfriamiento	Temp. °C	Sistema Descong.	Tipo GAS	Entrepaños Niveles	Dimensiones (L x P x H)
DELI-12	220V / 60Hz / 1F - 490W	Forzada x Aire frío	+4°C / +8°C	Automático x Resistencia	R134a	3	128x 115 x 138 cm

Avenida O'Higgins, Residencias Edif. La Arboleda, Local N° 1 – P.B. - Urb. Montalbán 1 – Caracas 1020  
Telfs.: (0212) 442.88.87 / 442.69.55 / 443.79.81

[www.gastronomica.com.ve](http://www.gastronomica.com.ve) - [ventas@gastronomica.com.ve](mailto:ventas@gastronomica.com.ve)